

Modlight Illumix Classic Line 24W

LED machine lamp, IP67, 24VDC, M12 connection

Art.No.: 4000-75801-1415024

Weight: 1.130 kg

Country of origin: DE

Model designation: Modlight Illumix Classic Line 24W

Modlight Illumix Classic Line
24 W

Link to Product

Illustration

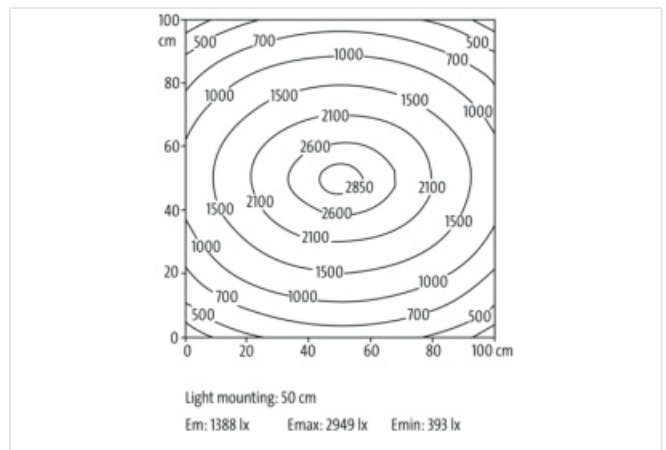
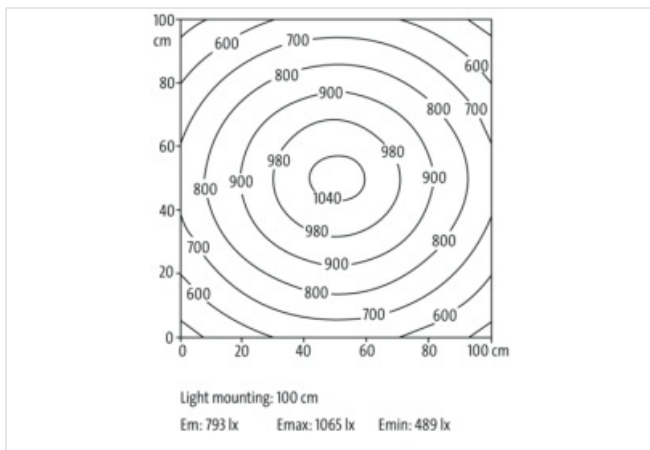
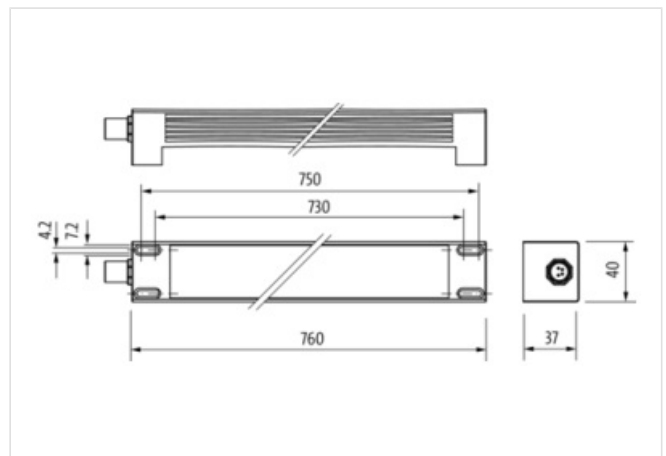

Product may differ from Image



Commercial data

URL Webshop	https://shop.murrelektronik.com/4000-75801-1415024
GTIN	4048879670838
Customs tariff number	94054239
ECLASS-6.0	27110306

ECLASS-6.1	27110390
ECLASS-7.0	27110390
ECLASS-7.1	27110390
ECLASS-8.0	27110390
ECLASS-8.1	27110390
ECLASS-9.0	27110345
ECLASS-9.1	27110345
ECLASS-10.0.1	27110345
ECLASS-10.1	27110345
ECLASS-11.0	27110345
ECLASS-11.1	27110345
ECLASS-12.0	27110345
ECLASS-13.0	27110345
ECLASS-14.0	27110345
ETIM-5.0	EC000348
ETIM-6.0	EC000348
ETIM-7.0	EC000348
ETIM-8.0	EC000348
customs tariff number	94054239
EAN	4048879670838
Packaging unit	1

Electrical data | Supply

Operating voltage DC	24 V
Operating voltage DC min.	21,6 V
Operating voltage DC max.	27,6 V
Power consumption max.	24 W

HMI | Illumination properties

Radiation angle min.	120 °
Luminous temperature	5.500 K
Color reproduction (Ra) min.	80
Luminous efficacy	157 lm/W
Light color	daylight white
Luminous flux	3.768 lm

Installation | Connection

Family construction form	M12
Gender	male

Installation | Pin assignment

Coding	A
No. of poles	4

Device protection | Electrical

Installation height max. ASL	2.000 m
Degree of protection (EN IEC 60529)	IP67

Device protection | Mechanical

Shock resistance (EN IEC 60068-2-27)	50 g 11 ms
Vibration resistance (EN IEC 60068-2-6)	10 mm (2 ... 9 Hz), 3 g (9 ... 200 Hz)

Mechanical data | Material data

housing	Aluminum
Coating housing	anodized
Material light cover	diffuse single-pane safety glass (ESG)
Thickness material light cover	4 mm

Mechanical data | Mounting data

Height	37 mm
Width	760 mm
Depth	40 mm
Screw head diameter max.	12 mm
Screw head thread max.	M5

Environmental characteristics | Climatic

Operating temperature min.	-30 °C
Operating temperature max.	50 °C
Relative humidity (operation)	5 % ... 95 %

Connection type 1

Family construction form	M8
No. of poles	4
Coding	A
Gender	male
PIN 1	n.c.
PIN 2	n.c.
PIN 3	0 V DC
PIN 4	24 V DC