

M8 male 0° / M12 female 90° A-cod.

PVC 3x0.25 ye UL/CSA 0.6m

Art.No.: 7000-88261-0100060

Weight: 0.035 kg

Country of origin: US

Model designation: MSDL0-H-R010_0.6

Advantages of our connectors:

Our connectors are versatile and specially optimised for industrial environments. All connectors are 100% tested during the manufacturing process to ensure the highest quality and reliability.

The contacts are gold-plated, which ensures optimum conductivity. Thanks to the high degree of protection, the connectors are ideal for demanding industrial environments. They are also vibration-resistant - this is ensured by the union nut with vibration protection.

Our connectors are resistant to oils and cooling lubricants, but resistance to aggressive media should be tested for each specific application. Different cable lengths available [on request](#)

If you are missing technical information? Please feel free to use our [dictionary](#) to find more technical details.

Product details:

Male straight – female 90°

M8 – M12, 3-pole

M12, A-coded

Art-No. 7005 - M12/M8 Lite - (plastic hexagonal screw) on request

Further cable lengths on request.

Plastic housings with good resistance against chemicals and oils.

The resistance to aggressive media should be individually tested for your application. Further details on request.

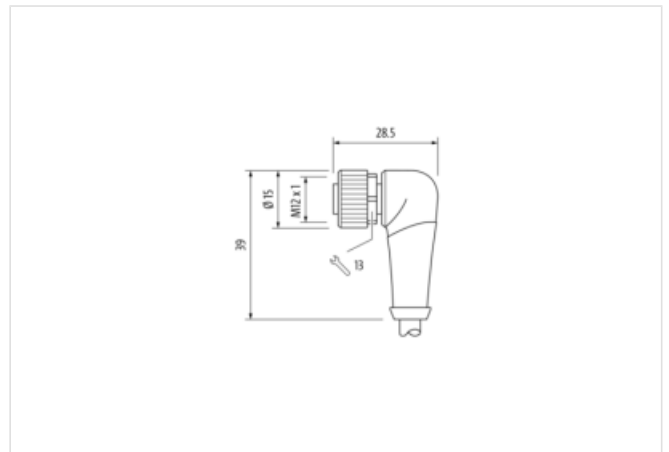
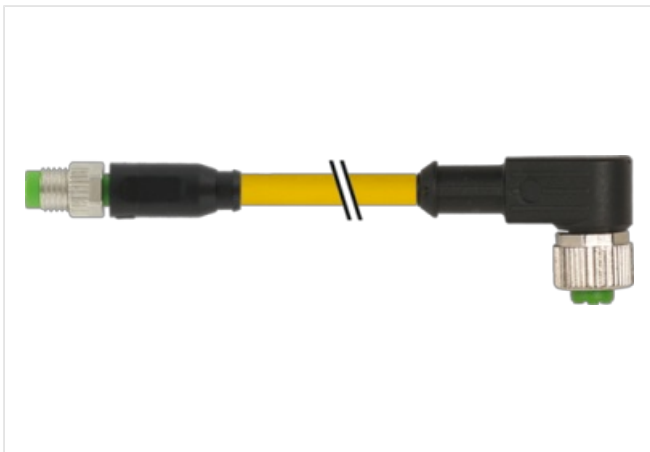
[Link to Product](#)**Illustration**

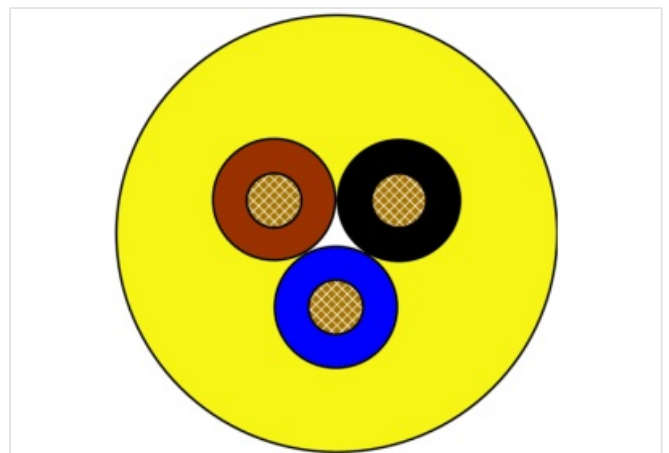
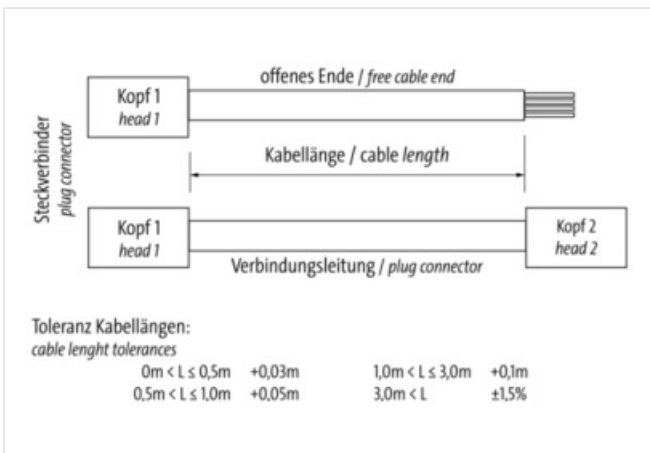
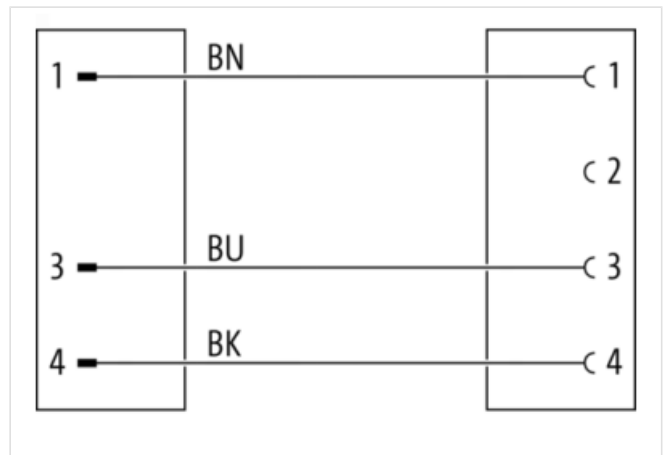
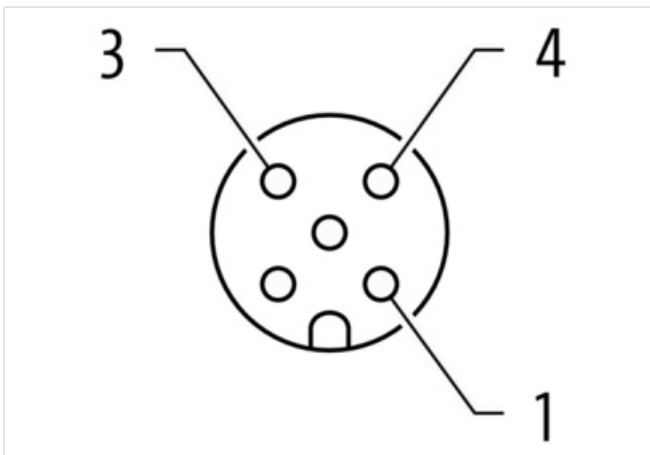

Product may differ from Image

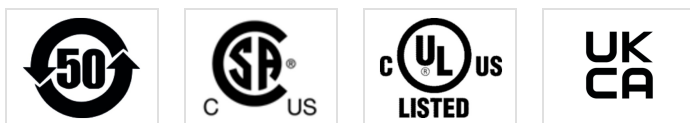

Cable length 0,60 m

Side 1

Family construction form M8

No. of poles	3
Coding	A
Mounting method	inserted, screwed
Threaded hole	M8 x 1
Tightening torque	0,4 Nm
Width across flats	SW9
suitable for corrugated tube (internal Ø)	6,5 mm
Material contact	Copper alloy
Coating contact	gold plated

Side 2

Family construction form	M12
No. of poles	3
Coding	A
Mounting method	inserted, screwed
Threaded hole	M12 x 1
Tightening torque	0,6 Nm
Width across flats	SW13
suitable for corrugated tube (internal Ø)	10 mm
Material contact	Copper alloy
Coating contact	gold plated

Commercial data

URL Webshop	https://shop.murrelektronik.com/7000-88261-0100060
Customs tariff number	85444290
customs tariff number	85444290
EAN	4048879686211
Packaging unit	1

Electrical data | Supply

Operating voltage AC max.	50 V
Operating voltage DC max.	60 V
Current operating per contact max.	4 A

Diagnostics

Status indication LED	No
-----------------------	----

Device protection | Electrical

Degree of protection (EN IEC 60529)	IP67, IP68, IP66K, IP65
Additional condition protection degree	inserted, screwed
Pollution Degree	3
Rated surge voltage	1,5 kV
Material group (IEC 60664-1)	I

Mechanical data | Material data

housing	PUR
Locking material	Zinc die-casting
Coating locking	Nickel
Gasket	FKM

Mechanical data | Mounting data

Mounting method	inserted, screwed, Shaking protection
-----------------	---------------------------------------

Environmental characteristics | Climatic

Operating temperature min.	-30 °C
Operating temperature max.	85 °C
Additional condition temperature range	depending on cable quality

Important installation notes

Note on bending radius

Attention: Observe the permissible bending radii when laying cables, as the IP protection class can be endangered by excessive bending forces.

Note on strain relief

Protect the connectors by suitable measures from mechanical loads, e.g. by the usage of cable ties.

Conformity

Product standard EN IEC 61076-2-101 (M12), EN IEC 61076-2-114 (M8)

Installation | Cable

Cable identification	010
Cable Type	1
Cable weight	26,7 g/m
UL AWM Style	2464 / 1731
Stranding	1 × 3 wires stranded
Wire arrangement	BN, BK, BU
Material wire insulation	PVC
Amount wires	3
Outer diameter insulation	1.25 mm ± 0.05 mm
Conductor crosssection (wire)	0,25 mm ²
Material conductor wire	Stranded copper wire, bare
Core construction (wire)	14 × 0.15 mm
Material properties wire insulation	good machinability
Ingredient freeness wire insulation	lead-free, cadmium-free, CFC-free, silicone-free
Material jacket	PVC
Outer-diameter (jacket)	4.5 mm ± 5 %
Jacket Color	yellow / RAL 1021
Freedom from ingredients (jacket)	lead-free, cadmium-free, CFC-free, silicone-free
Material property (jacket)	good machinability
Conductor resistance (wire)	79 Ω/km @ 20 °C
Nominal voltage max.	300 V
Withstand voltage (wire - wire)	2 kV @ 60 s
Withstand voltage (wire - jacket)	2 kV @ 60 s
Current load capacity max. (wire)	4,5 A
Current load capacity (standard)	to DIN VDE 0298-4
Operating temperature (static)	-30 °C ... 80 °C
Operating temperature (dynamic)	-5 °C ... 80 °C
Flame resistance	UL 1581 § 1080, CSA FT1, IEC 60332-1-2
Oil resistance	good
Chemical resistance	good
Other resistances	good resistance to gasoline
Notes	application-related testing
Bending radius (fixed)	5 × Outer diameter
Bending radius (dynamic)	10 × Outer diameter