

**Valve plug MJC 0° with cable V2A**

PUR 2x0.75 bk UL/CSA+drag ch. 7.5m

Xtreme - Outdoor

Female straight

0...230 V AC/DC

without components

Stainless steel 1.4305 (V2A)

Plastic housings with good resistance against chemicals and oils.

The resistance to aggressive media should be individually tested for your application. Further details on request.

Further cable lengths on request.

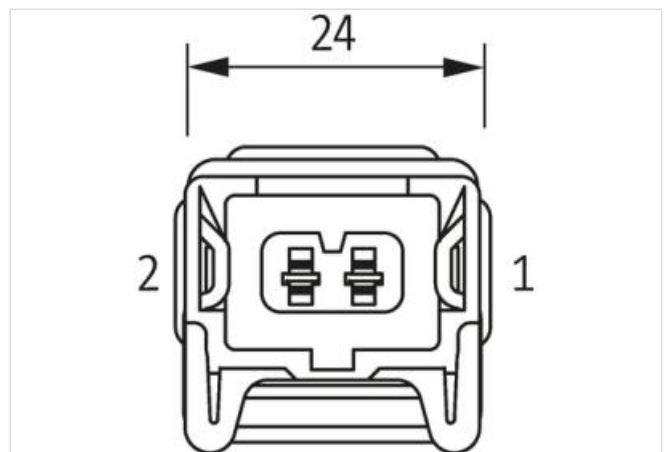
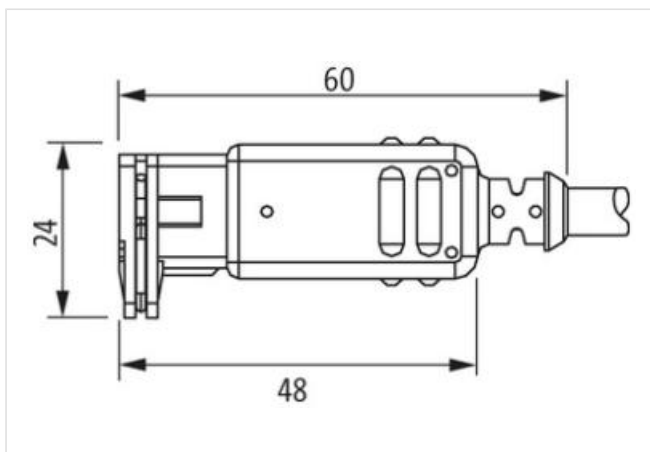
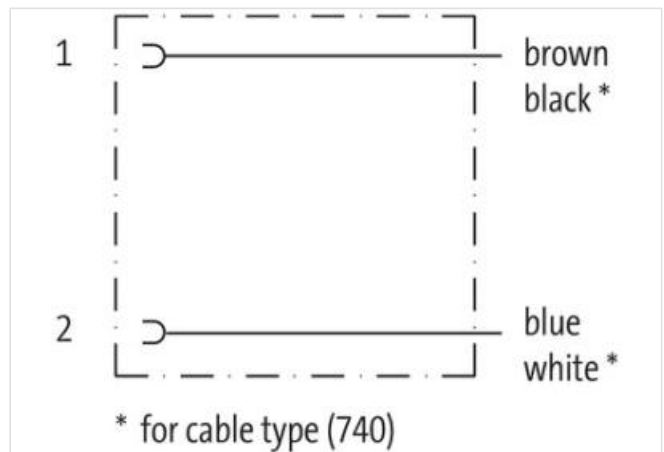
**[Link to Product](#)****Illustration**

Product may differ from Image

Cable length 7,5 m

**Commercial data**

ECLASS-6.0	27279218
ECLASS-7.0	27279218
ECLASS-8.0	27279218
ECLASS-9.0	27060311

ECLASS-10.1	27060312
ECLASS-11.1	27060312
ECLASS-12.0	27060312
ETIM-5.0	EC001855
customs tariff number	85444290
GTIN	4048879303743
Packaging unit	1

**Electrical data | Supply**

Operating voltage AC max.	230 V
Operating voltage DC max.	230 V
Current operating per contact max.	4 A

**Device protection | Electrical**

Degree of protection (EN IEC 60529)	IP65
Additional condition protection degree	inserted, locked

**Device protection | Media**

Flame resistance	flame retardant
------------------	-----------------

**Mechanical data | Material data**

Color housing	black
Material housing	Plastic
Locking material	Stainless steel 1.4305 (V2A)

**Environmental characteristics | Climatic**

Operating temperature min.	-25 °C
Operating temperature max.	85 °C
Additional condition temperature range	depending on cable quality

**Important installation notes**

Note on strain relief	Protect the connectors by suitable measures from mechanical loads, e.g. by the usage of cable ties.
Note on bending radius	<b>Attention:</b> Observe the permissible bending radii when laying cables, as the IP protection class can be endangered by excessive bending forces.

**Installation | Cable**

wire arrangement	brown, blue
Cable identification	754
Cable Type	3
Jacket Color	black
Type of Certificate	cURus
Amount stranding	1
Stranding	2 wires twisted
wire arrangement	brown, blue
Cable weight	40,7 g/m
Material jacket	PUR
Shore hardness jacket	90 ± 5 Shore A
Freedom from ingredients (jacket)	lead-free, cadmium-free, CFC-free, halogen-free, silicone-free
Outer-diameter (jacket)	5 mm
Tolerance outer diameter (sheath)	± 5 %
Material wire insulation	PP
Amount wires	2
Outer diameter insulation	1,7 mm
Outer diameter tolerance core insulation	± 5 %
Shore hardness wire insulation	70 ± 5 Shore D
Ingredient freeness wire insulation	lead-free, cadmium-free, CFC-free, halogen-free, silicone-free
Amount strands (wire)	42
Diameter of single wires	0,15 mm
Conductor crosssection (wire)	0,75 mm <sup>2</sup>

Material conductor wire	Stranded copper wire, bare
Conductor type (wire)	strand class 6
Nominal voltage AC max.	300 V
Current load capacity (standard)	to DIN VDE 0298-4
Current load capacity min. wire	12 A
Electrical resistance line constant wire	26 $\Omega$ /km @ 20 °C
AC withstand voltage (wire - wire)	2,5 kV @ 60 s
Power frequency withstand voltage (wire - jacket)	2,5 kV @ 60 s
Min. operating temperature (static)	-40 °C
Max. operating temperature (fixed)	80 °C / 90 °C @ 10000 h Operation
Operating temperature min. (dynamic)	-25 °C
Operating temperature max. (dynamic)	80 °C / 90 °C @ 10000 h Operation
UV resistance	DIN EN ISO 4892-2 A
Flame resistance	UL 1581 § 1090   UL 1581 § 1100 FT2   IEC 60332-2-2
chemical resistance	Good, application-related testing
Gasoline resistance	Good, application-related testing
Oil resistance	DIN EN 60811-404   Good, application-related testing
Bending radius (fixed)	5 x Outer diameter
Bending radius (dynamic)	10 x Outer diameter
No. of bending cycles (C-track)	10 Mio. @ 25 °C
Traversing distance (C-track)	10 m @ 25 °C   horizontal
Travel speed (C-track)	3 m/s @ 25 °C
No. of torsion cycles	2 Mio.
Torsion stress	$\pm$ 180 °/m
Torsion speed	35 cycles/min